

General Description

The MIC29310 and MIC29312 are low cost versions of MIC29300 family low-dropout (LDO) regulators. Manufactured on Micrel's proprietary Super beta PNP™ process, the MIC29310/2 is a 3A LDO regulator with very low-dropout voltage (600mV over the full load) and low ground current. Along with a total accuracy of ±2% (over temperature, line and load regulation) these regulators feature very fast transient recovery from input voltage surges and output load current changes.

The MIC29310 is available in fixed 3.3V and 5V outputs voltages; the MIC29312 has an adjustable output which can be set by two external resistors to a voltage between 1.24V to 15V. In addition, all versions are fully protected against overcurrent faults, reversed input polarity, reversed lead insertion, and overtemperature operation.

A TTL logic enable (EN) pin is available in the MIC29312 to shutdown the regulator. When not used, the device can be set to continuous operation by connecting EN to the input (IN).

The MIC29310/2 is available in the standard 3- and 5-pin TO-220 and TO-263 packages with an operating junction temperature range of 0°C to +125°C.

For applications requiring even lower dropout voltage, input voltage greater than 16V, or an error flag, see the MIC29300/29301/29302/29303.

Features

- Low cost versions of MIC29300 family
- Fast transient response
- 3A current over full temperature range
- 600mV dropout voltage at full load
- Low ground current
- Accurate 1% guaranteed tolerance
- "Zero" current shutdown mode (MIC29312)
- Fixed voltage and adjustable versions

Applications

- Processor peripheral and I/O supplies
- PC add-in cards
- High-efficiency "green" computer systems
- High-efficiency linear power supplies
- High-efficiency switching supply post regulator
- Battery-powered equipment

Ordering Information

Part Number	Voltage	Junction Temp. Range	Package
MIC29310-3.3BT	3.3V	0°C to +125°C	TO-220-3
MIC29310-3.3BU	3.3V	0°C to +125°C	TO-263-3
MIC29310-5.0BT	5.0V	0°C to +125°C	TO-220-3
MIC29310-5.0BU	5.0V	0°C to +125°C	TO-263-3
MIC29312BT	Adj.	0°C to +125°C	TO-220-5
MIC29312BU	Adj.	0°C to +125°C	TO-263-5

Typical Application

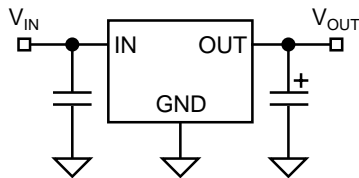

Fixed Regulator Configuration

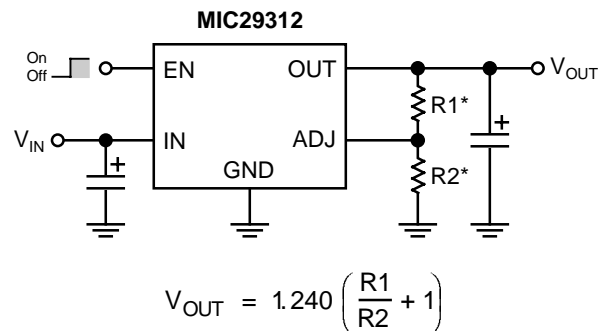

* For best performance, total series resistance ($R1 + R2$) should be small enough to pass the minimum regulator load current of 10mA.

Adjustable Regulator Configuration

Pin Configuration

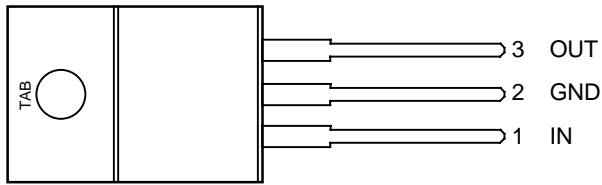

MIC29310-x.xBT
TO-220 (T)

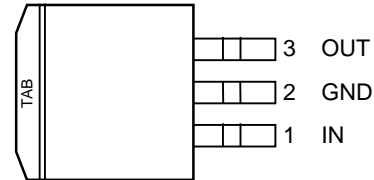

MIC29310-x.xBU
TO-263 (U)

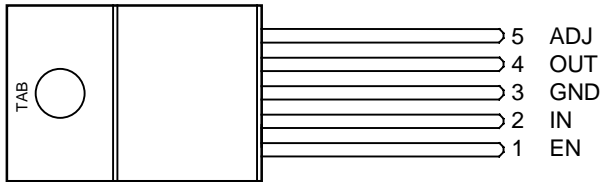

MIC29312-x.xBT
TO-220-5 (T)

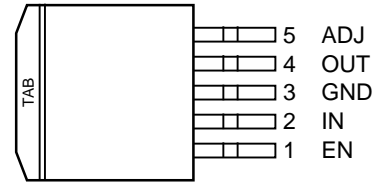

MIC29312-x.xBU
TO-263-5 (U)

Pin Description

Pin Number MIC29310	Pin Number MIC29312	Pin Name	Pin Function
	1	EN	Enable (Input): Active-high, logic-level enable/shutdown control.
1	2	IN	Unregulated Input: +16V maximum supply.
2, TAB	3, TAB	GND	Ground: Ground pin and TAB are internally connected.
3	4	OUT	Regulator Output
	5	ADJ	Output Voltage Adjust: 1.24V feedback from external resistive divider.

Absolute Maximum Ratings (Note 1)

Input Voltage (V_{IN}) -20V to +20V
 Power Dissipation (P_D) Internally Limited
 Storage Temperature Range (T_S) -65°C to +150°C
 Lead Temperature (soldering, 5 sec.) 260°C
 ESD, **Note 3**

Operating Ratings (Note 2)

Input Voltage (V_{IN}) +2.3V to +16V
 Junction Temperature (T_J) 0°C to +125°C
 Package Thermal Resistance
 TO-263 (θ_{JC}) 2°C/W
 TO-220 (θ_{JC}) 2°C/W
 TO-220 (θ_{JA}) 55°C/W

Electrical Characteristics

$T_J = 25^\circ\text{C}$, **bold** values indicate $0^\circ\text{C} \leq T_J \leq +125^\circ\text{C}$; unless noted

Parameter	Condition	Min	Typ	Max	Units
Output Voltage	$10\text{mA} \leq I_O \leq I_{FL}$, $(V_{OUT} + 1\text{V}) \leq V_{IN} \leq 8\text{V}$, Note 4	-2		2	%
Line Regulation	$I_O = 10\text{mA}$, $(V_{OUT} + 1\text{V}) \leq V_{IN} \leq 16\text{V}$		0.06	0.5	%
Load Regulation	$V_{IN} = V_{OUT} + 1\text{V}$, $10\text{mA} \leq I_{OUT} \leq I_{FULL\ LOAD}$, Notes 4, 8		0.2	1	%
$\Delta V_O / \Delta T$	Output Voltage Temperature Coefficient, Note 8		20	100	ppm/ $^\circ\text{C}$
Dropout Voltage	$\Delta V_{OUT} = -1\%$, Note 5 $I_O = 100\text{mA}$ $I_O = 750\text{mA}$ $I_O = 1.5\text{A}$ $I_O = 3\text{A}$		80 220 330 600	200 1000	mV mV mV mV
Ground Current	$I_O = 750\text{mA}$, $V_{IN} = V_{OUT} + 1\text{V}$ $I_O = 1.5\text{A}$ $I_O = 3\text{A}$		5 15 60	20 150	mA mA mA
I_{GNDDO} Ground Pin Current at Dropout	$V_{IN} = 0.5\text{V}$ less than specified V_{OUT} . $I_{OUT} = 10\text{mA}$		2	3	mA
Current Limit	$V_{OUT} = 0\text{V}$, Note 6	3.0	3.8		A
Minimum Load Current			7	10	mA
e_n , Output Noise Voltage (10Hz to 100kHz) $I_L = 100\text{mA}$	$C_L = 10\mu\text{F}$ $C_L = 33\mu\text{F}$		400 260		μV_{RMS} μV_{RMS}

Reference (MIC29312 only)

Reference Voltage	$10\text{mA} \leq I_O \leq I_{FL}$, $V_{OUT} + 1\text{V} \leq V_{IN} \leq 8\text{V}$, Note 4	1.215		1.265	V_{MAX}
Adjust Pin Bias Current			40	80 120	nA nA
Reference Voltage Temperature Coefficient	Note 9		20		ppm/ $^\circ\text{C}$
Adjust Pin Bias Current Temperature Coefficient			0.1		nA/ $^\circ\text{C}$

Enable Input (MIC29312 only)

Input Logic Voltage	low (off) high (on)	2.4		0.8	V V
Enable Pin Input Current	$V_{EN} = V_{IN}$		15	30 75	μA μA
	$V_{EN} = 0.8\text{V}$		–	2 4	μA μA
Regulator Output Current in Shutdown	Note 10		10	20	μA μA

Note 1. Exceeding the absolute maximum rating may damage the device.

Note 2. The device is not guaranteed to function outside its operating rating.

Note 3. Devices are ESD sensitive. Handling precautions recommended.

Note 4: Full Load current is defined as 3A for the MIC29310/29312. For testing, V_{OUT} is programmed to 5V.

Note 5: Dropout voltage is defined as the input-to-output differential when the output voltage drops to 99% of its nominal value with $V_{OUT} + 1\text{V}$ applied to V_{IN} .

Note 6: For this test, V_{IN} is the larger of 8V or $V_{OUT} + 3\text{V}$.

Note 7: Ground pin current is the regulator quiescent current. The total current drawn from the source is the sum of the load current plus the ground pin current.

Note 8: Output voltage temperature coefficient is defined as the worst case voltage change divided by the total temperature range.

Note 9: $V_{REF} \leq V_{OUT} \leq (V_{IN} - 1\text{V})$, $2.4\text{V} \leq V_{IN} \leq 16\text{V}$, $10\text{mA} < I_L \leq I_{FL}$, $T_J \leq T_{J(max)}$.

Note 10: $V_{EN} \leq 0.8\text{V}$ and $V_{IN} \leq 8\text{V}$, $V_{OUT} = 0$.

Block Diagram

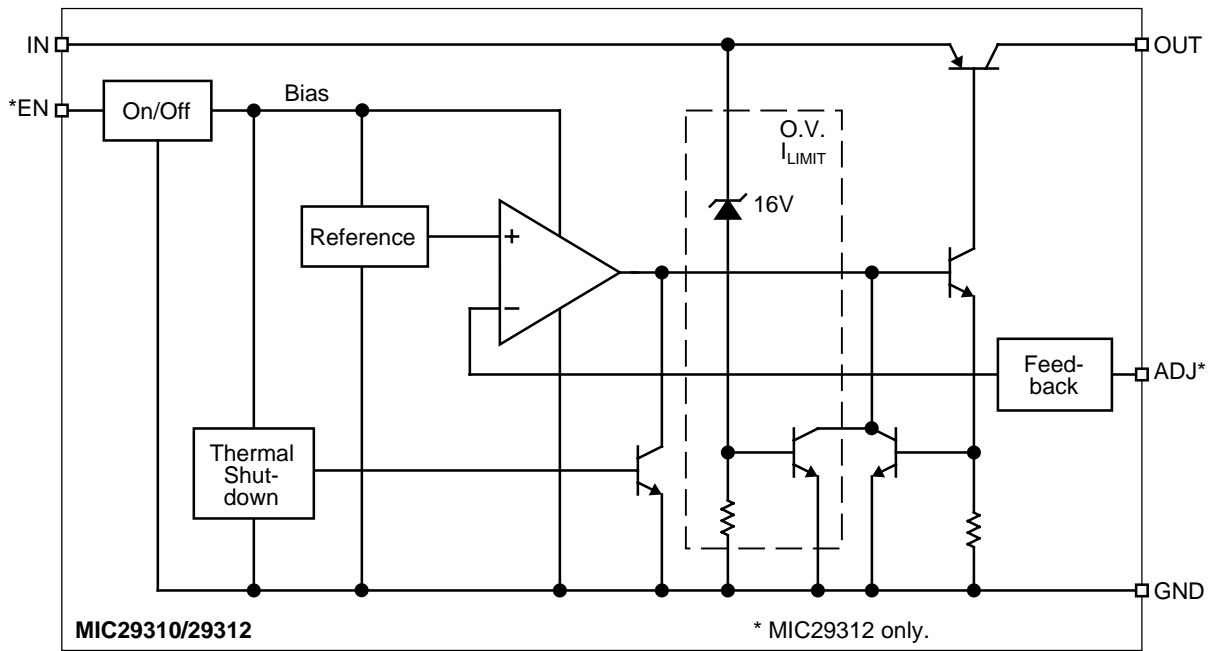

Typical Characteristics

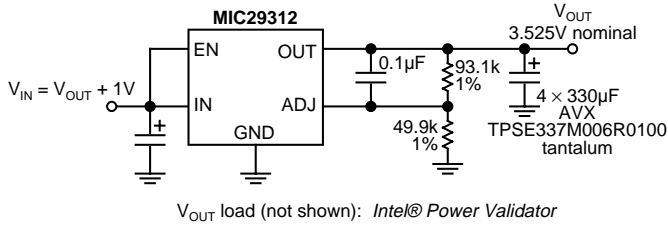

MIC29312 Load Transient Response Test Circuit

MIC29312 Load Transient Response (See Test Circuit Schematic)

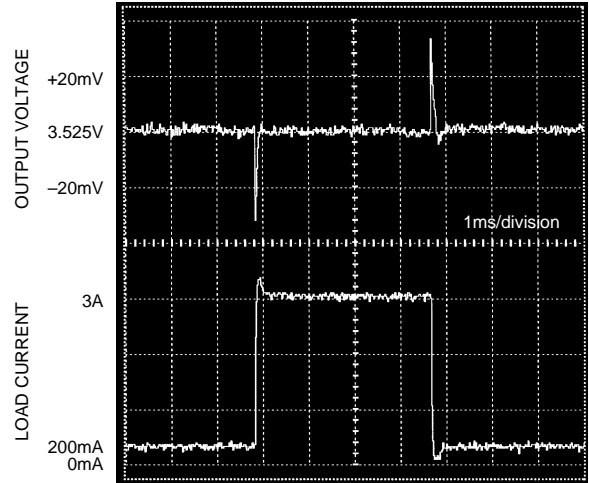

MIC29312 Line Transient Response with 3A Load, 10µF Output Capacitance

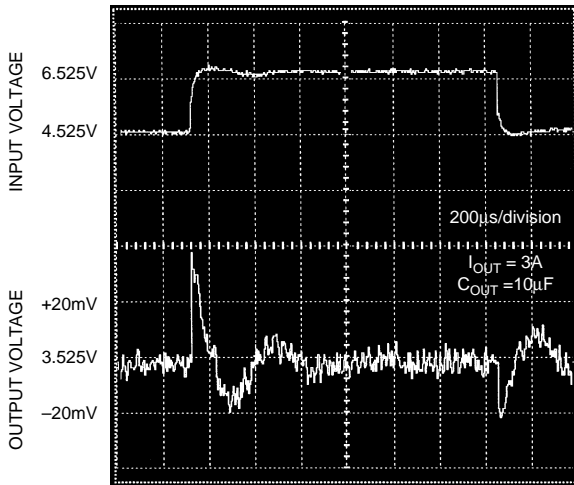

MIC29312 Line Transient Response with 3A Load, 100µF Output Capacitance

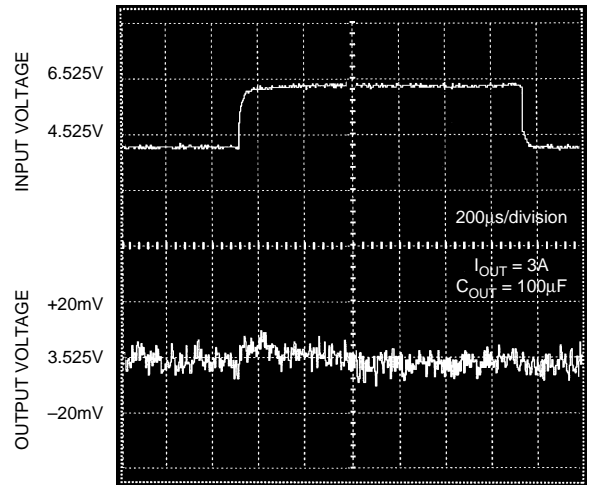

MIC2931x Dropout Voltage vs. Output Current

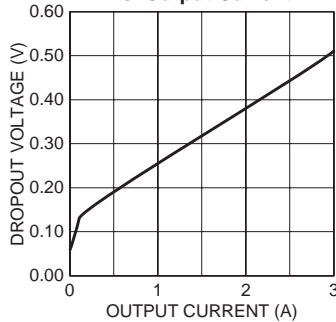

MIC2931x Dropout Voltage vs. Temperature

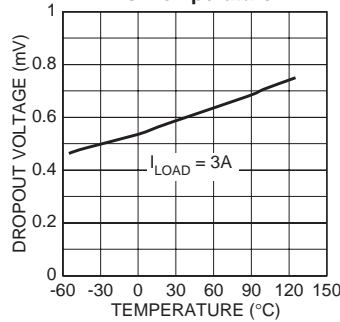

MIC29310-3.3 Dropout Characteristics

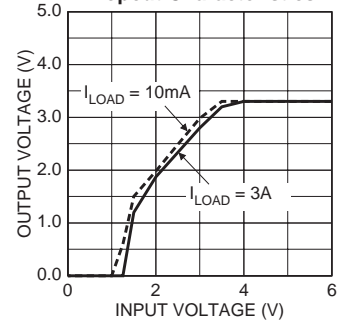

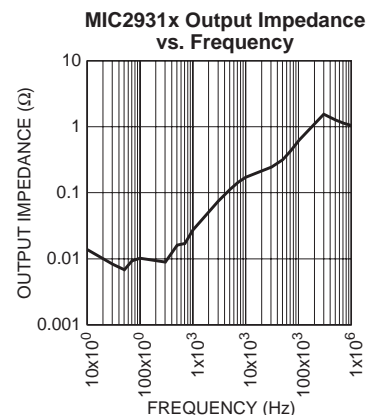
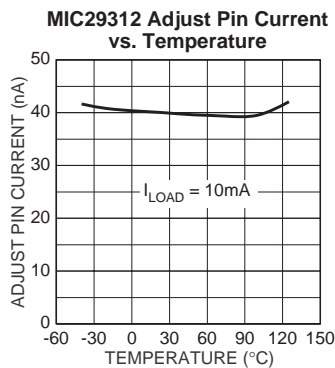
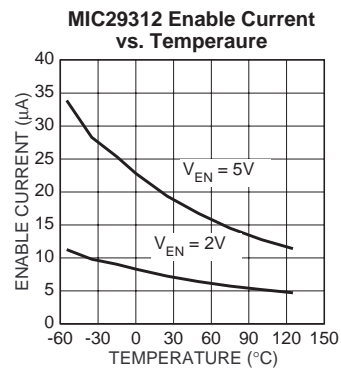
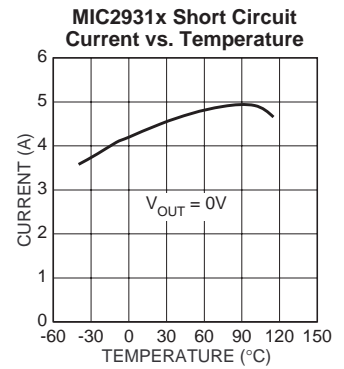
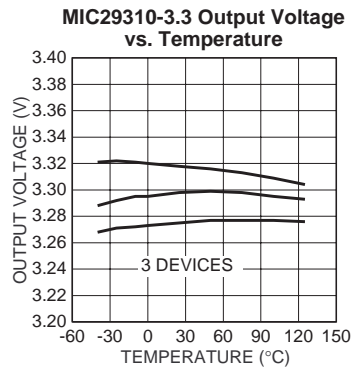
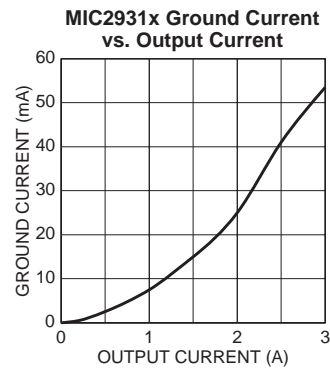
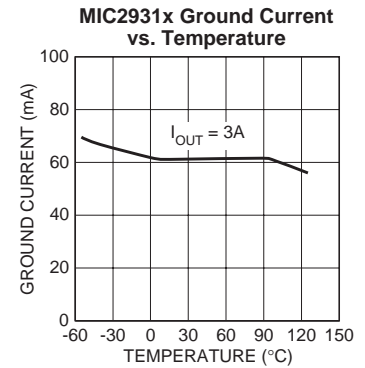
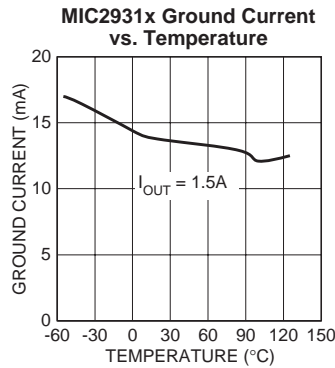
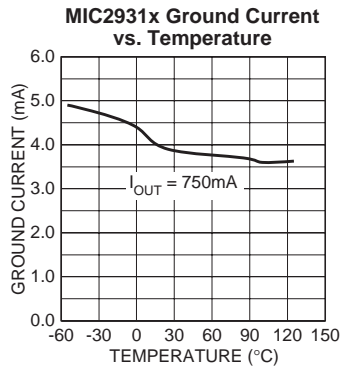
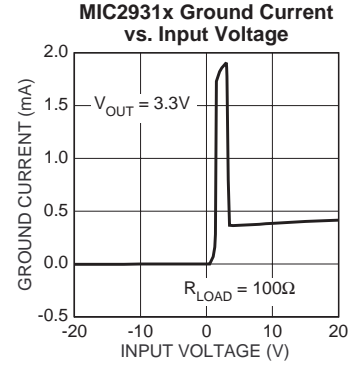
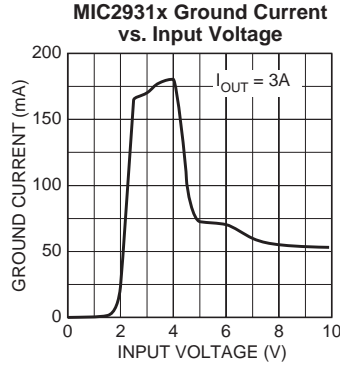
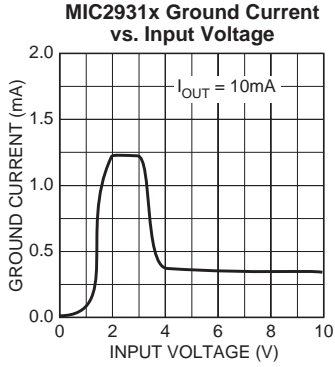

Applications Information

The MIC29310 and MIC29312 are high performance low-dropout voltage regulators suitable for all moderate to high-current voltage regulator applications. Their 600mV of dropout voltage at full load make them especially valuable in battery powered systems and as high efficiency noise filters in “post-regulator” applications. Unlike older NPN-pass transistor designs, where the minimum dropout voltage is limited by the base-emitter voltage drop and collector-emitter saturation voltage, dropout performance of the PNP output of these devices is limited merely by the low V_{CE} saturation voltage.

A trade-off for the low dropout voltage is a varying base drive requirement. But Micrel's Super β PNP™ process reduces this drive requirement to merely 2% to 5% of the load current.

MIC29310/312 regulators are fully protected from damage due to fault conditions. Current limiting is provided. This limiting is linear; output current under overload conditions is constant. Thermal shutdown disables the device when the die temperature exceeds the maximum safe operating temperature. Transient protection allows device (and load) survival even when the input voltage spike above and below nominal. The output structure of these regulators allows voltages in excess of the desired output voltage to be applied without reverse current flow. The MIC29312 version offers a logic level ON/OFF control: when disabled, the devices draw nearly zero current.

An additional feature of this regulator family is a common pinout: a design's current requirement may change up or down yet use the same board layout, as all of Micrel's high-current Super β PNP™ regulators have identical pinouts.

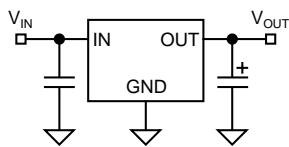

Figure 3. The MIC29310 regulator requires only two capacitors for operation.

Thermal Design

Linear regulators are simple to use. The most complicated design parameters to consider are thermal characteristics. Thermal design requires the following application-specific parameters:

- Maximum ambient temperature, T_A
- Output Current, I_{OUT}
- Output Voltage, V_{OUT}
- Input Voltage, V_{IN}

First, we calculate the power dissipation of the regulator from these numbers and the device parameters from this datasheet.

$$P_D = I_{OUT} \times (1.02V_{IN} - V_{OUT})$$

Where the ground current is approximated by 2% of I_{OUT} . Then the heat sink thermal resistance is determined with this formula:

$$\theta_{SA} = \frac{T_{J\ MAX} - T_A}{P_D} - (\theta_{JC} + \theta_{CS})$$

Where $T_{J\ MAX} \leq 125^\circ\text{C}$ and θ_{CS} is between 0 and 2°C/W .

The heat sink may be significantly reduced in applications where the minimum input voltage is known and is large compared with the dropout voltage. Use a series input resistor to drop excessive voltage and distribute the heat between this resistor and the regulator. The low dropout properties of Micrel Super β PNP regulators allow very significant reductions in regulator power dissipation and the associated heat sink without compromising performance. When this technique is employed, a capacitor of at least $0.1\mu\text{F}$ is needed directly between the input and regulator ground.

Please refer to Application Note 9 for further details and examples on thermal design and heat sink specification.

Capacitor Requirements

For stability and minimum output noise, a capacitor on the regulator output is necessary. The value of this capacitor is dependent upon the output current; lower currents allow smaller capacitors. MIC29310/2 regulators are stable with a minimum capacitor value of $10\mu\text{F}$ at full load.

This capacitor need not be an expensive low ESR type: aluminum electrolytics are adequate. In fact, extremely low ESR capacitors may contribute to instability. Tantalum capacitors are recommended for systems where fast load transient response is important.

Where the regulator is powered from a source with a high AC impedance, a $0.1\mu\text{F}$ capacitor connected between Input and GND is recommended. This capacitor should have good characteristics to above 250kHz.

Transient Response and 5V to 3.3V Conversion

The MIC29310/2 have excellent response to variations in input voltage and load current. By virtue of their low dropout voltage, these devices do not saturate into dropout as readily as similar NPN-based designs. A 3.3V output Micrel LDO will maintain full speed and performance with an input supply as low as 4.2V, and will still provide some regulation with supplies down to 3.8V, unlike NPN devices that require 5.1V or more for good performance and become nothing more than a resistor under 4.6V of input. Micrel's PNP regulators provide superior performance in “5V to 3.3V” conversion applications than NPN regulators, especially when all tolerances are considered.

Minimum Load Current

The MIC29310/2 regulators are specified between finite

loads. If the output current is too small, leakage currents dominate and the output voltage rises. A 10mA minimum load current is necessary for proper regulation.

Adjustable Regulator Design

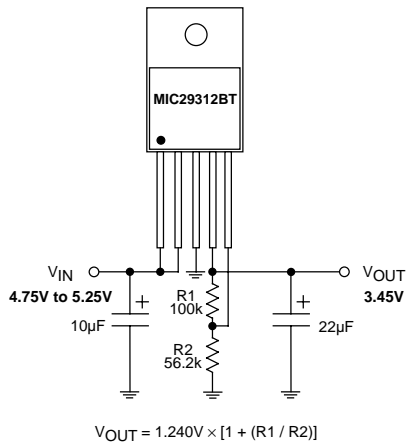

Figure 4. Adjustable Regulator with Resistors

The adjustable regulator version, MIC29312, allows programming the output voltage anywhere between 1.25V and the 15V maximum operating rating of the family. Two resistors are used. Resistors can be quite large, up to 1M Ω , because of the very high input impedance and low bias

current of the sense comparator. The resistor values are calculated by:

$$R1 = R2 \times \left(\frac{V_{OUT}}{1.240} - 1 \right)$$

Where V_O is the desired output voltage. Figure 4 shows component definition. Applications with widely varying load currents may scale the resistors to draw the minimum load current required for proper operation (see the table below).

Enable Input

The MIC29312 version features an enable (EN) input that allows ON/OFF control of the device. Special design allows “zero” current drain when the device is disabled—only microamperes of leakage current flows. The EN input has TTL/CMOS compatible thresholds for simple interfacing with logic, or may be directly tied to V_{IN} . Enabling the regulator requires approximately 20 μ A of current into the EN pin.

Resistor Value Table for the MIC29312 Adjustable Regulator

Voltage	Standard (Ω)		Min. Load (Ω)	
	R1	R2	R1	R2
2.85	100k	76.8k	162	124
2.9	100k	75.0k	165	124
3.0	100k	69.8k	174	124
3.1	100k	66.5k	187	124
3.15	100k	64.9k	191	124
3.3	100k	60.4k	205	124
3.45	100k	56.2k	221	124
3.6	100k	52.3k	237	124
3.8	100k	48.7k	255	124
4.0	100k	45.3k	274	124
4.1	100k	43.2k	287	124

Note: This regulator has a minimum load requirement. “Standard” values assume the load meets this requirement. “Minimum Load” values are calculated to draw 10mA and allow regulation with an open load (the minimum current drawn from the load may be zero).

Package Information

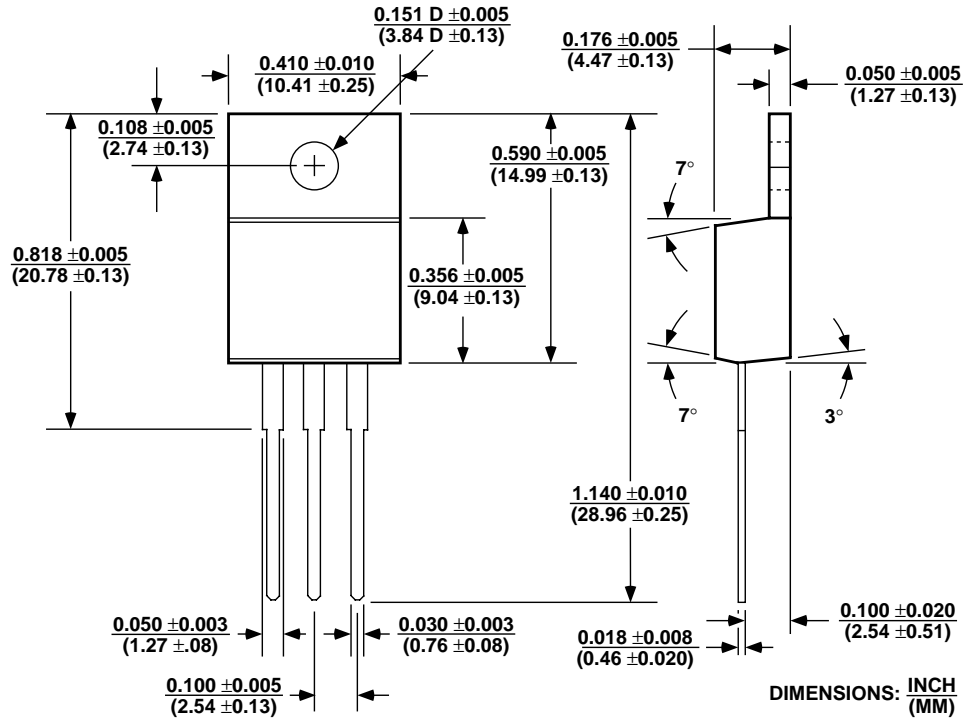

TO-220-3 (T)

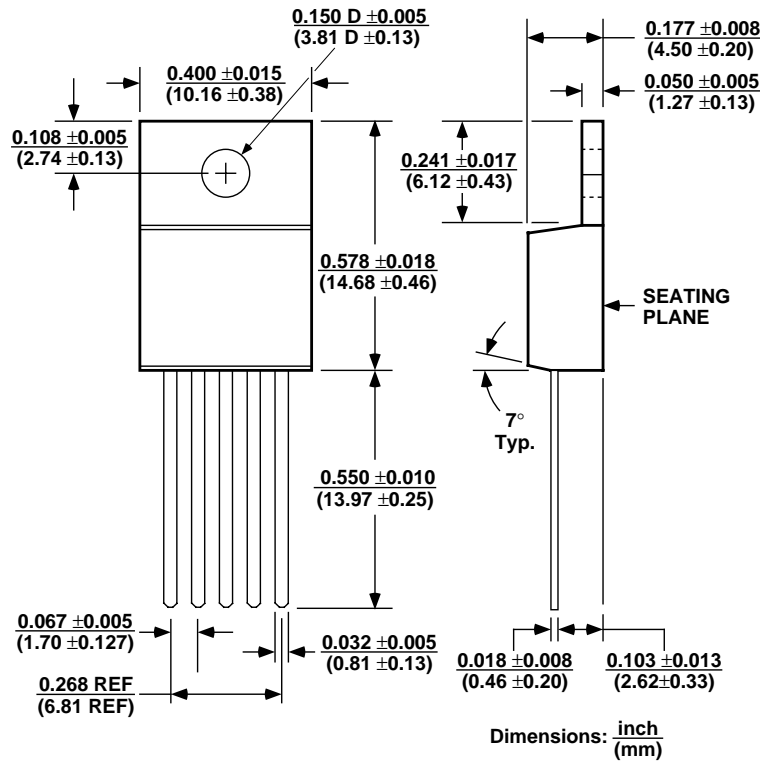

TO-220-5 (T)

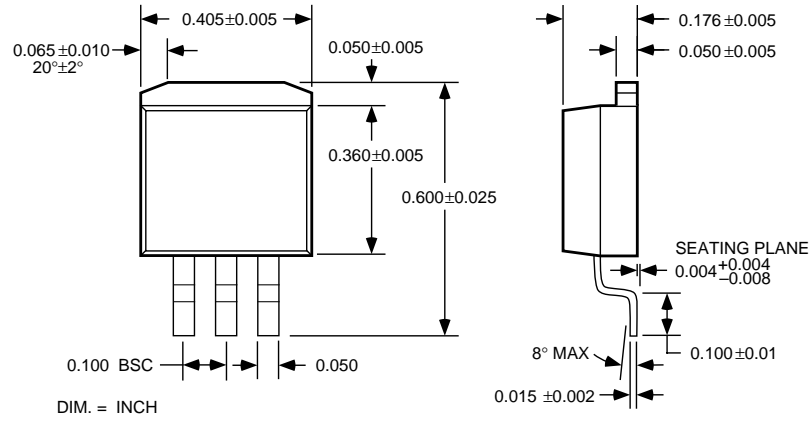

TO-263-3 (U)

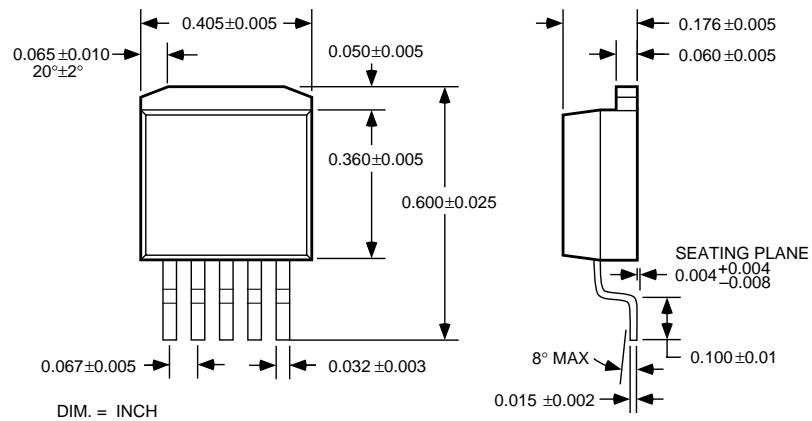

TO-263-5 (U)

MICREL INC. 1849 FORTUNE DRIVE SAN JOSE, CA 95131 USA

TEL + 1 (408) 944-0800 FAX + 1 (408) 944-0970 WEB <http://www.micrel.com>

This information is believed to be accurate and reliable, however no responsibility is assumed by Micrel for its use nor for any infringement of patents or other rights of third parties resulting from its use. No license is granted by implication or otherwise under any patent or patent right of Micrel Inc.

© 1999 Micrel Incorporated